



# Installation instructions, accessories

Volvo Car Corporation Gothenburg, Sweden

Instruction No	Version	Part. No.
31428111	1.2	31442556

## Mirror, rearview, autodimming

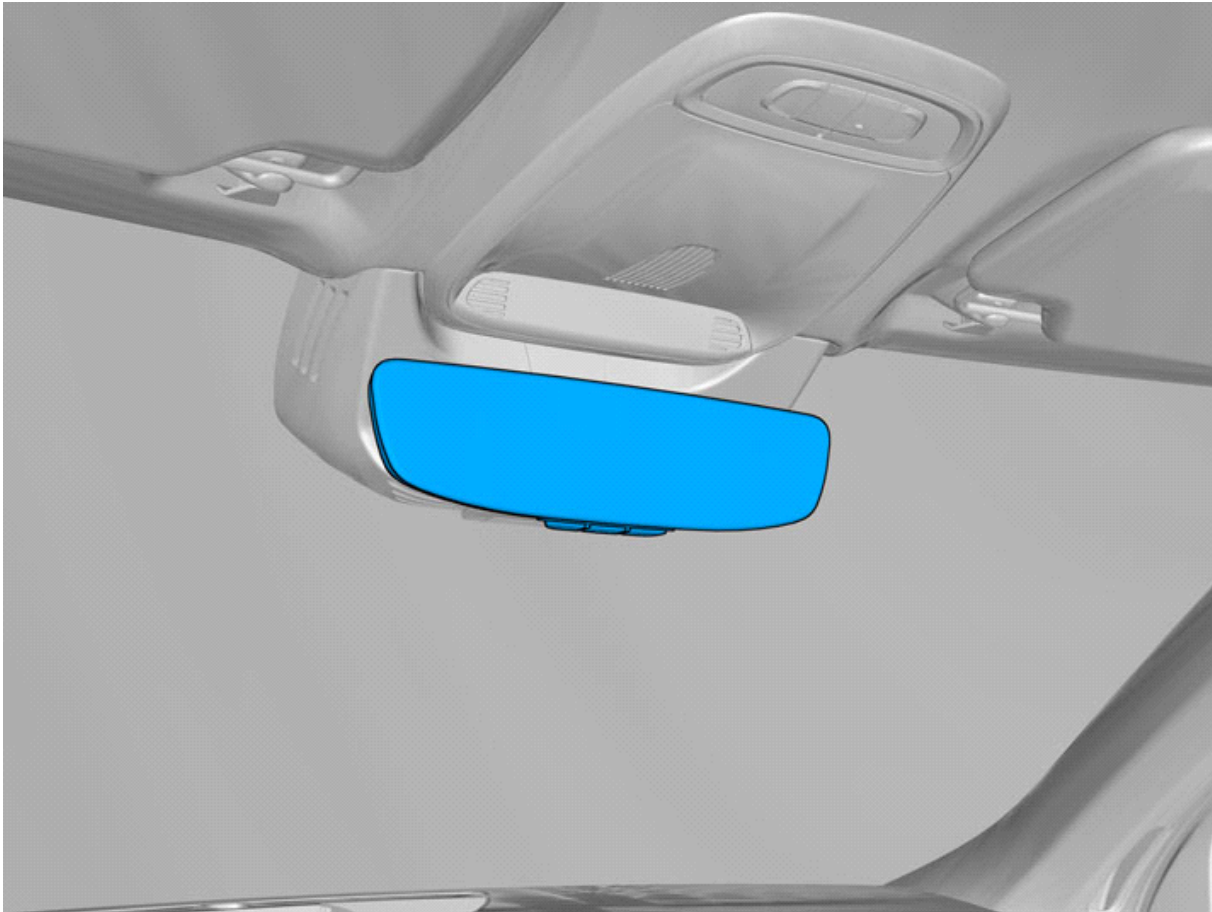

IMG-382373



# Installation instructions, accessories

Volvo Car Corporation Gothenburg, Sweden

## Equipment

# VIDA

IMG-242205

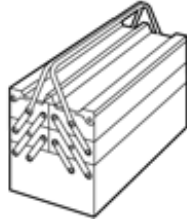

IMG-345497

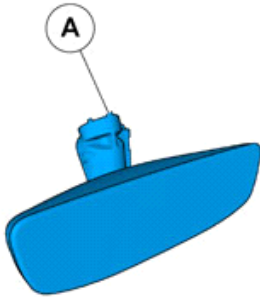

IMG-382376



# Installation instructions, accessories

Volvo Car Corporation Gothenburg, Sweden

## Information

1

Read through all of the instructions before starting installation.

Notifications and warning texts are for your safety and to minimise the risk of something breaking during installation.

Ensure that all tools stated in the instructions are available before starting installation.

Certain steps in the instructions are only presented in the form of images. Explanatory text is also given for more complicated steps.

In the event of any problems with the instructions or the accessory, contact your local Volvo dealer.

## Color symbols

2

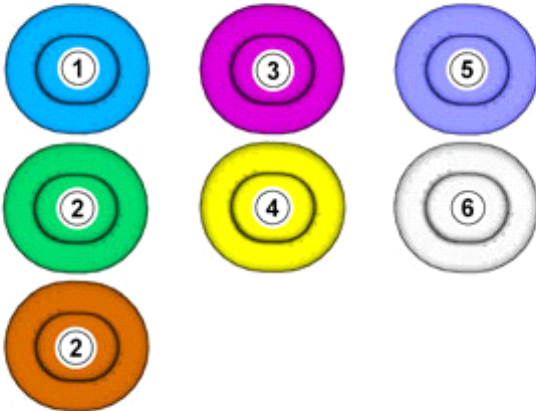

IMG-363036

### Note!

This colour chart displays (in colour print and electronic version) the importance of the different colours used in the images of the method steps.

- Used for focused component, the component with which you will do something.
- Used as extra colors when you need to show or differentiate additional parts.
- Used for attachments that are to be removed/installed. May be screws, clips, connectors, etc.
- Used when the component is not fully removed from the vehicle but only hung to the side.
- Used for standard tools and special tools.
- Used as background color for vehicle components.

## Removal



# Installation instructions, accessories

Volvo Car Corporation Gothenburg, Sweden

3



IMG-394535

4

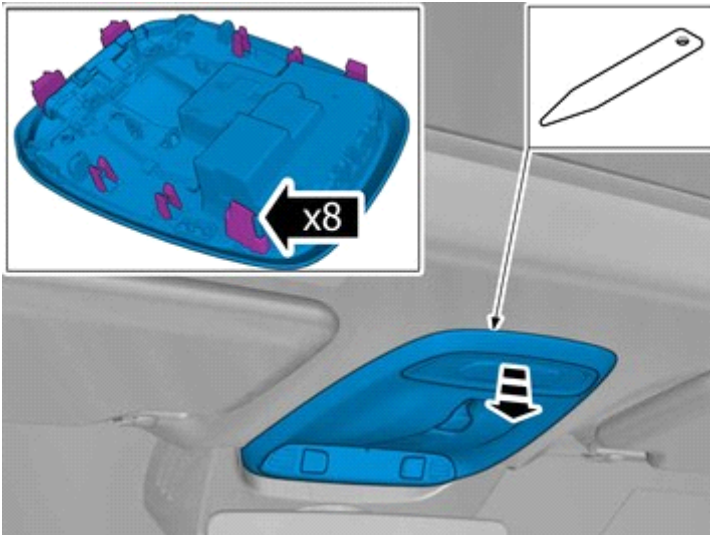

IMG-397174

Remove the panel.

5

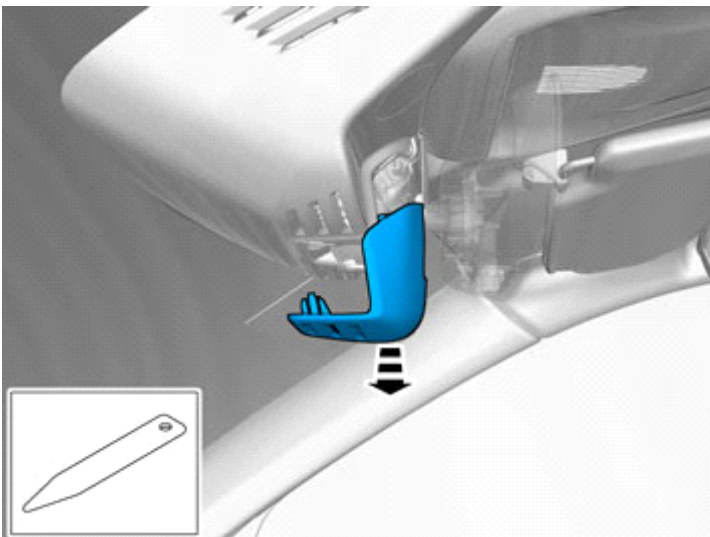

IMG-382384

Remove the panel.



# Installation instructions, accessories

Volvo Car Corporation Gothenburg, Sweden

6

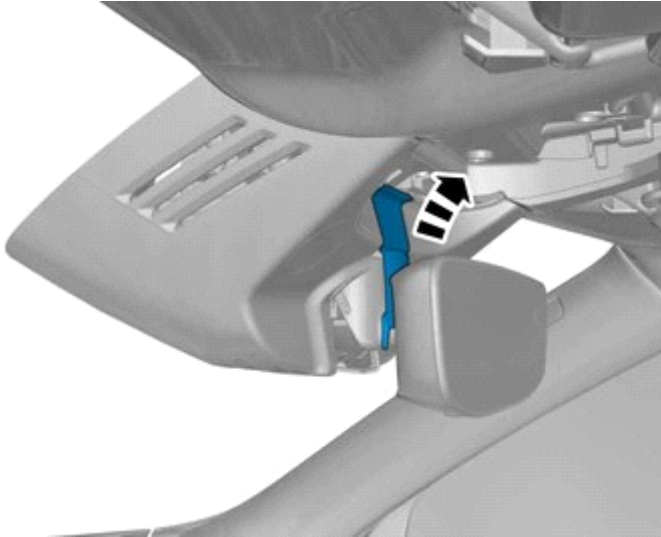

IMG-397175

Remove the panel.

7

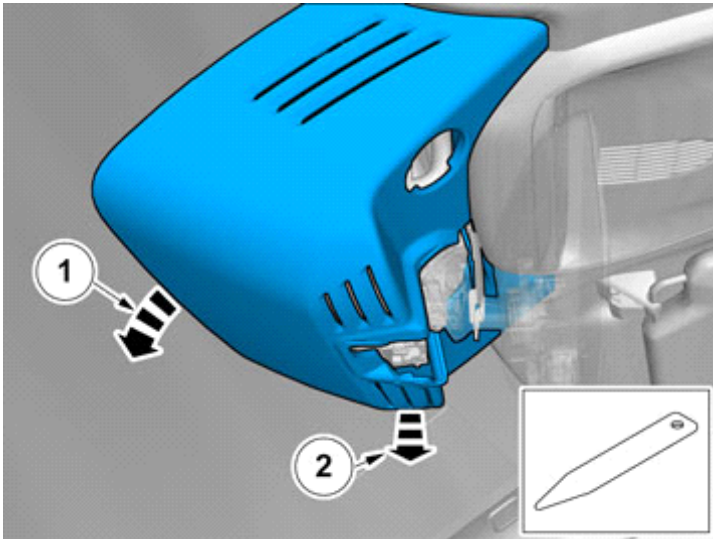

IMG-382385

Remove the panel.

8

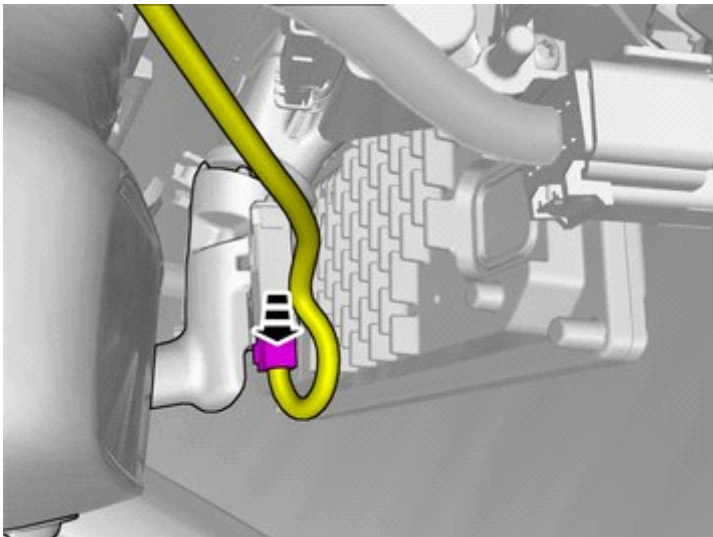

IMG-396420

Disconnect the connector.



# Installation instructions, accessories

Volvo Car Corporation Gothenburg, Sweden

9

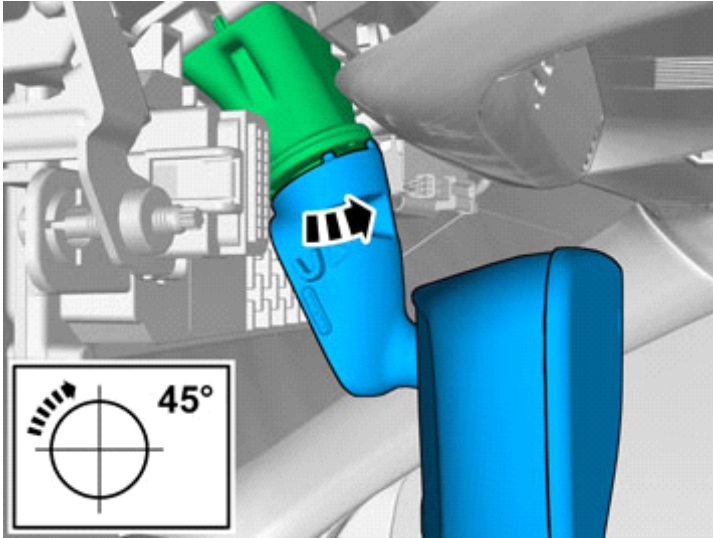

IMG-382394

## Accessory installation

10

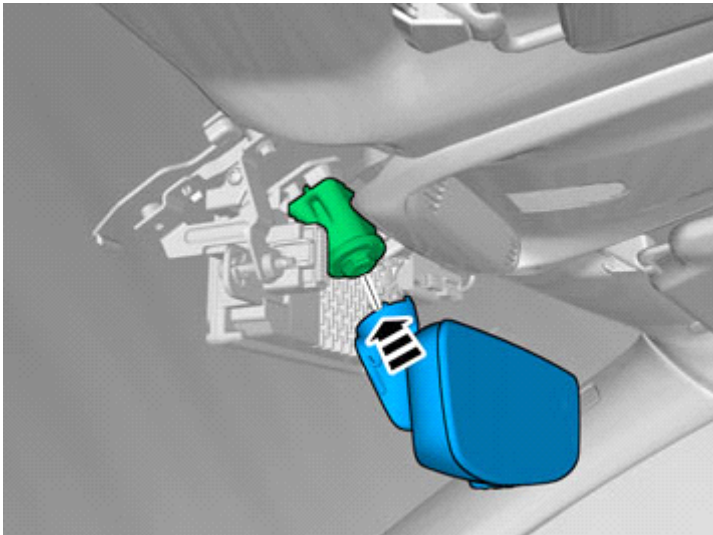

IMG-382396

Install component that comes with the accessory kit.





# Installation instructions, accessories

Volvo Car Corporation Gothenburg, Sweden

11

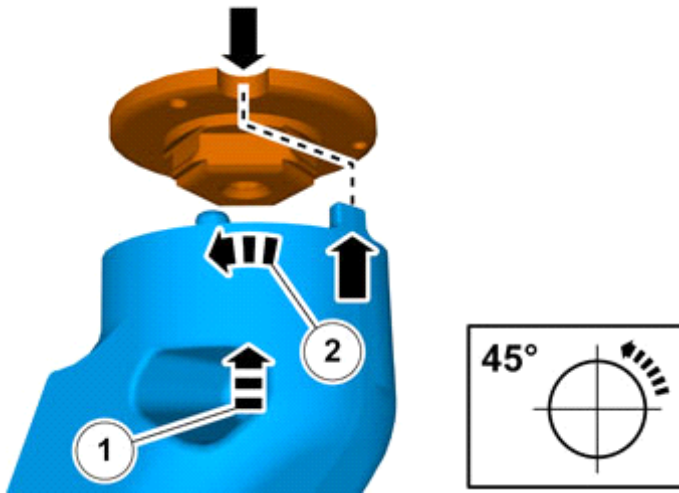

IMG-338619

12

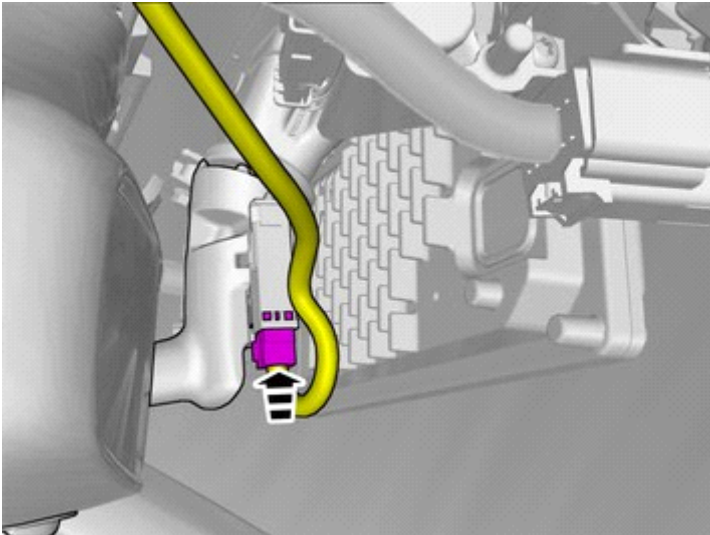

IMG-396421

Connect the connector.

13

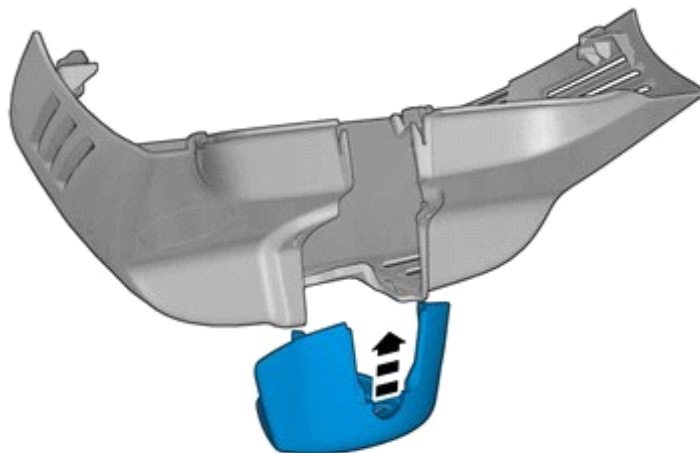

Install the panel.

IMG-397176



# Installation instructions, accessories

Volvo Car Corporation Gothenburg, Sweden

14

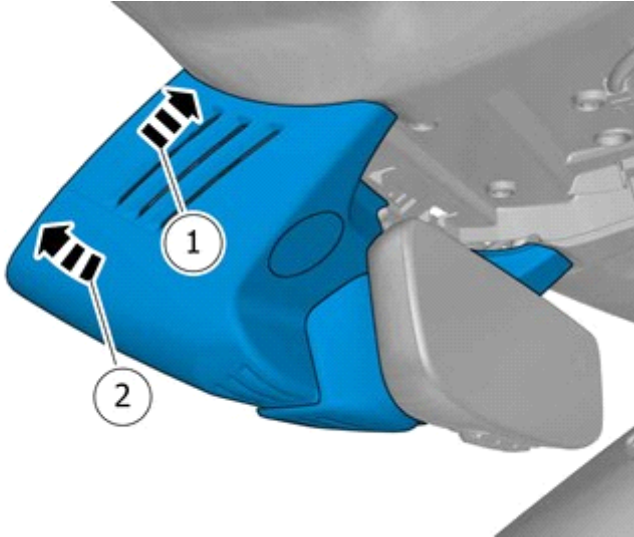

Install the panel.

IMG-397178

15

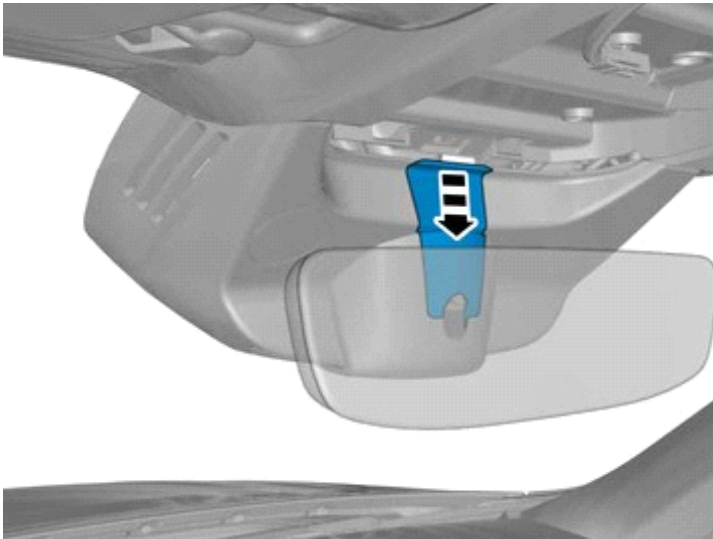

Install the panel.

IMG-397177

16

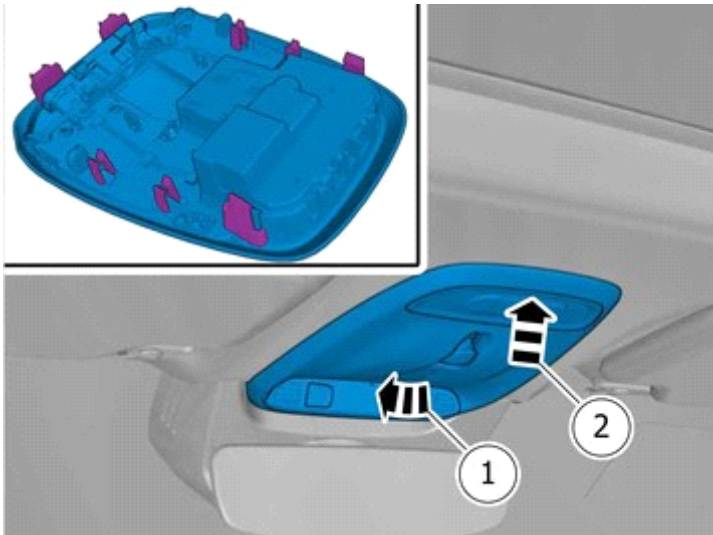

Install the panel.

IMG-397179





# Installation instructions, accessories

Volvo Car Corporation Gothenburg, Sweden

17

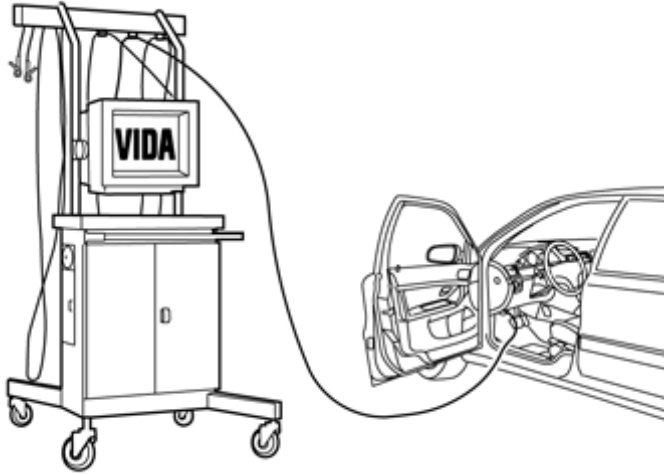

IMG-242268

Download software (application) for the accessory's function according to the service information in VIDA. See VIDA or the accessories catalogue for software part number.

---

## Calibration

18

Compass

Refer to Owner's manual

---